

薄型外同軸

Flat Square Dome Light

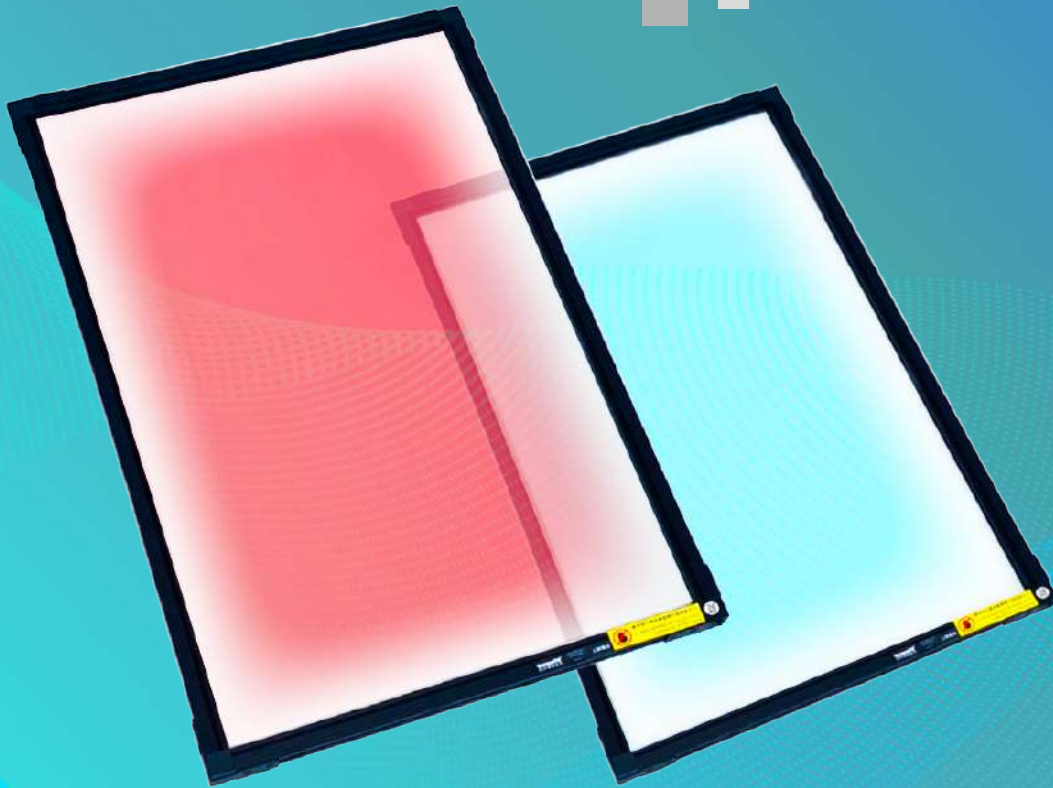

- ▶ 尺寸最大560mm*322mm，**超廣檢測視野**，完美包覆待測物的暗角
Large area. Wide uniform field of illumination.
- ▶ **14mm**的薄度，適用於各種
長短焦距鏡不干涉
Slim flat. Easy installation (compact thickness).

- ▶ 高透明度、高均勻度、高亮度（鱗片散熱）
亮度比它牌提升 2 倍
High transparency. High uniform illumination (> 80%).
High power (Heatsink-fin).
- ▶ **高價效比**
Cost-Efficient.

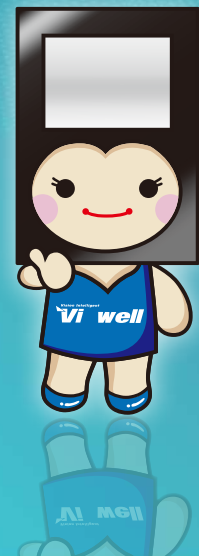
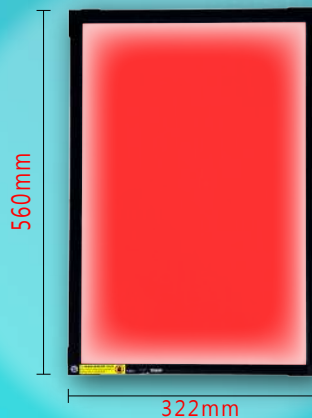

薄型外同軸

Flat Square Dome Light

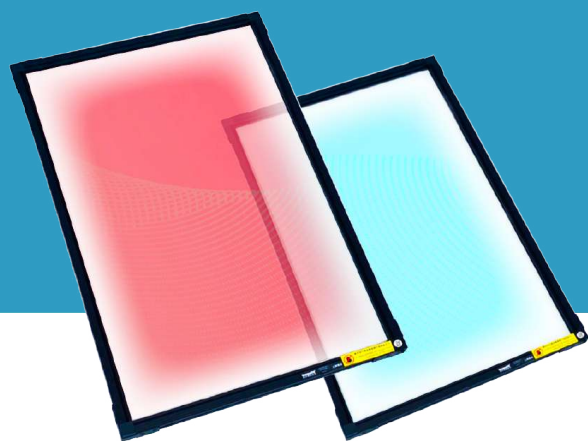

產品特色

- ▶ 特殊光學材質設計, 提供高透明、高亮度、高均勻度的同軸照明
- ▶ 產品厚度只有14mm超輕薄, 特別適合一般外同軸厚重空間限制無法安裝之嚴苛環境
- ▶ 照明範圍從145x120mm到最大560x322mm可供選用
- ▶ 超高CP值, 價格不到一般外同軸的一半, 適合預算有限之照明應用
- ▶ 可搭配overdriving控制 提升10倍亮度

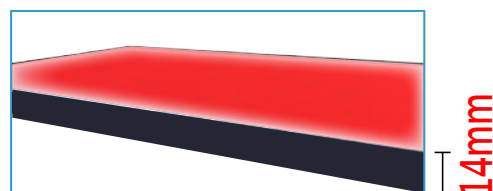

適合用途

- ▶ 影像無反光或炫光亮點, 最適合檢測鏡面反光物體的各種特徵或缺陷使用
- ▶ 適合鏡面反光或高反射係數物體的檢測使用。例如: PCB裸板、底片的對位、標記辨識及缺陷檢查
- ▶ 各種玻璃、鍍膜或金屬易反光材質表面之刮傷、凹陷或標記辨識
- ▶ 晶圓或面板產業之面板成品, 玻璃基板、濾光片的對位、標記辨識及缺陷檢查



▲ FSDL-560322實際照射

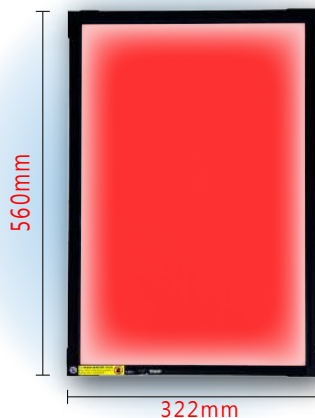

▲ FSDL-560322

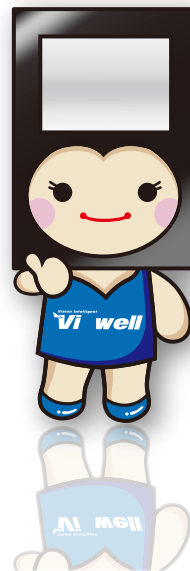

光強特性圖

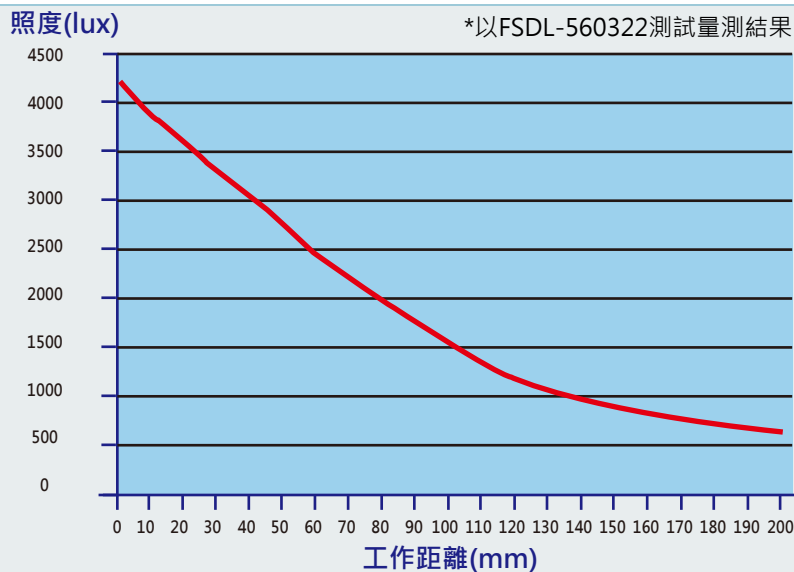

型號說明



產品規格表

型號 (Model)	顏色 (Color)	發光區域 (Emitting Area)	消耗功率 (Power Consumption)	外觀尺寸 (Dimension)
FSDL-145120	○ ● ● ● ● ● ● ●	145X120	○ ● ● ● ● ● ● ● 24V/13W ● ● 24V/13W	A
FSDL-197170	○ ● ● ● ● ● ● ●	197X170	○ ● ● ● ● ● ● ● 24V/18W ● ● 24V/18W	B
FSDL-278197	○ ● ● ● ● ● ● ●	278X197	○ ● ● ● ● ● ● ● 24V/18W ● ● 24V/18W	C
FSDL-435300	○ ● ● ● ● ● ● ●	435X300	○ ● ● ● ● ● ● ● 24/33.6W ● ● 24/33.6W	D
FSDL-560322	○ ● ● ● ● ● ● ●	560X322	○ ● ● ● ● ● ● ● 24V/58W ● ● 24V/58W	E

註：1. ○白光 ●藍光 ●綠光 ●紅光 ●橘光 ●850nm紅外線光 ●940nm紅外線光 2.單位：mm

打光方式

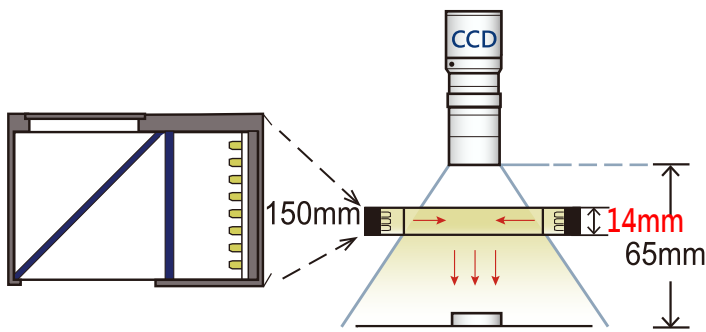

外同軸 CL-150140

薄型外同軸 FSDL-145120

均勻性

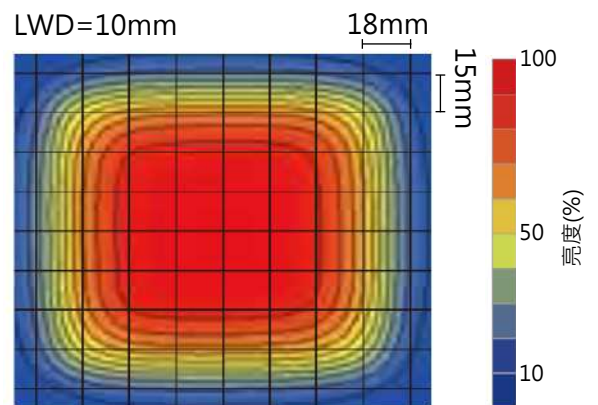

*以FSDL-145120量測

註：所含數據僅供參考，個別產品的結果可能會有所不同。若均勻度要>80%，上下左右要各扣除30mm較安全。

工作距說明

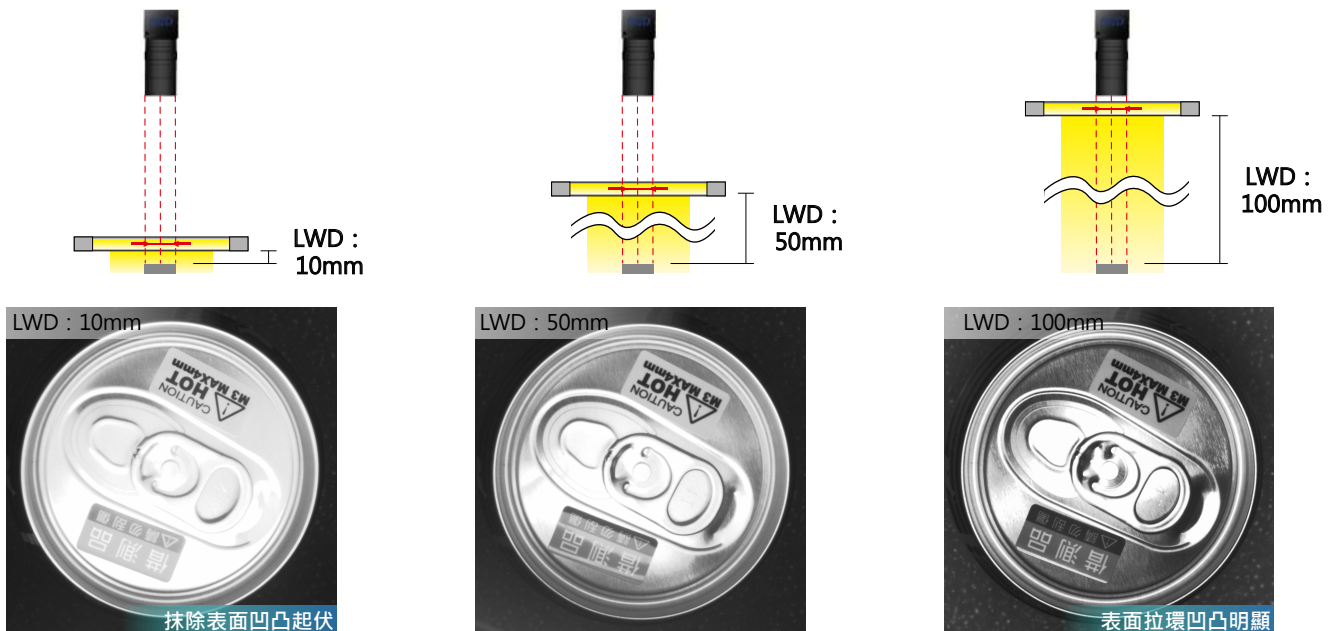

工作距小為漫射光可減少反光或抹除凹凸起伏，工作距大為平行光可凸顯刮傷及凹凸起伏。

光譜圖

白光光譜

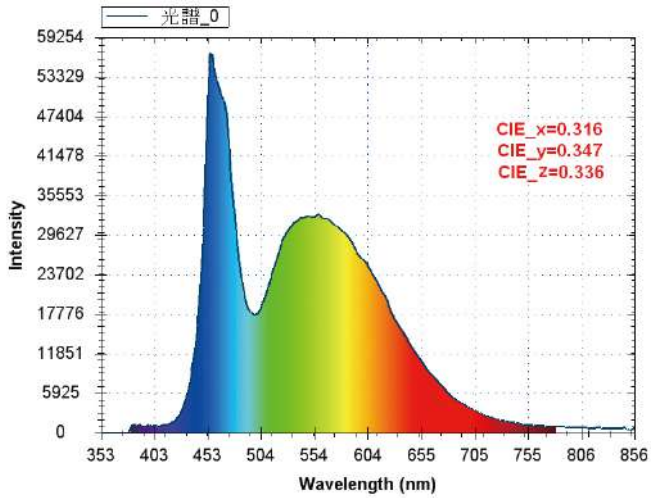

紅光光譜

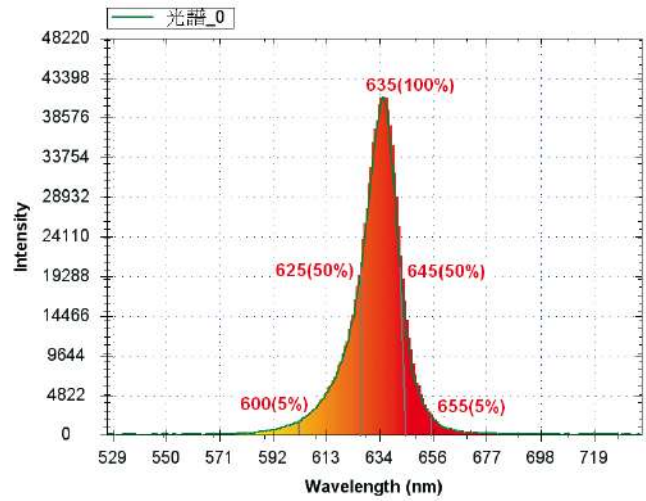

藍光光譜

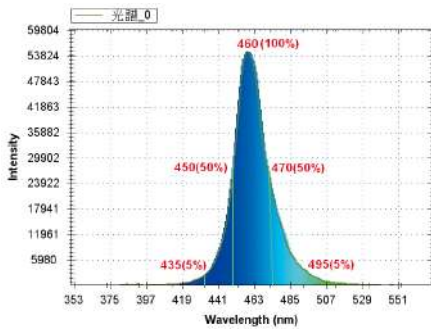

綠光光譜

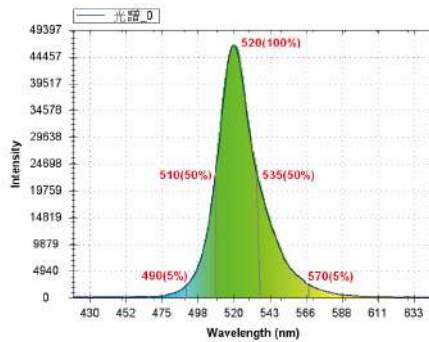

橘光光譜

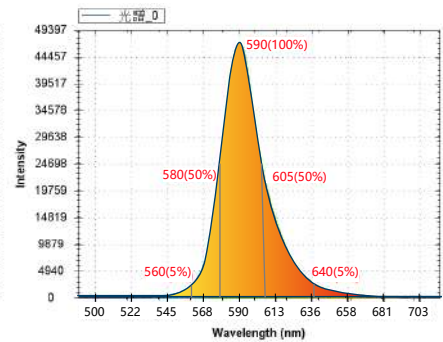

操作說明

提高光源工作距或放大光圈可減少光板髒污對影像的影響

將鏡頭光圈調整為大光圈

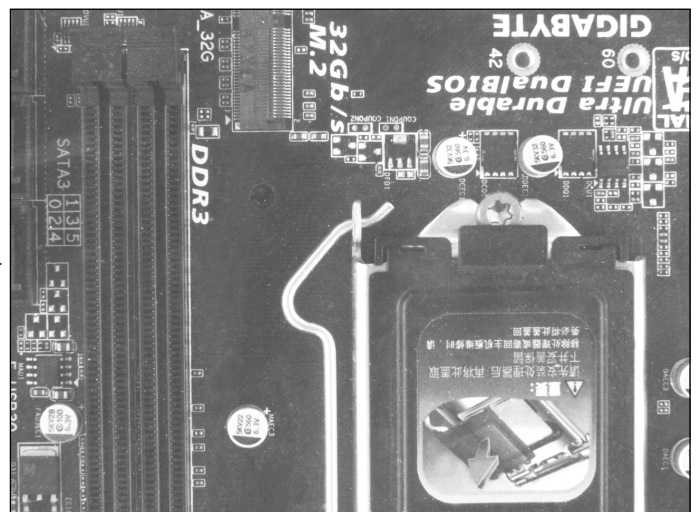
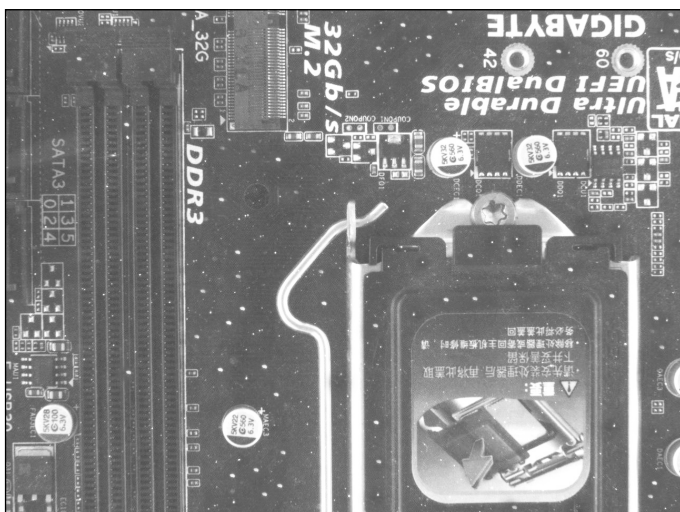
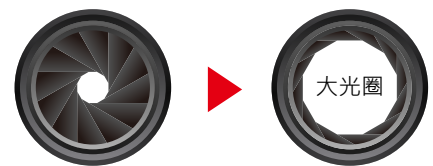

*環境光可能會從照明表面或工件表面反射，影響成像。

環形光源 (白光)

薄型外同軸 (白光)

洋芋片

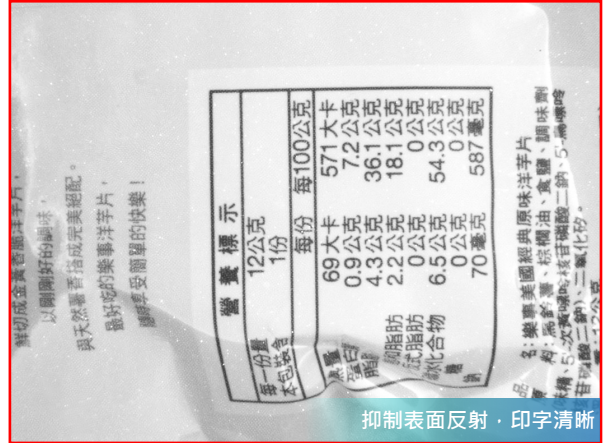
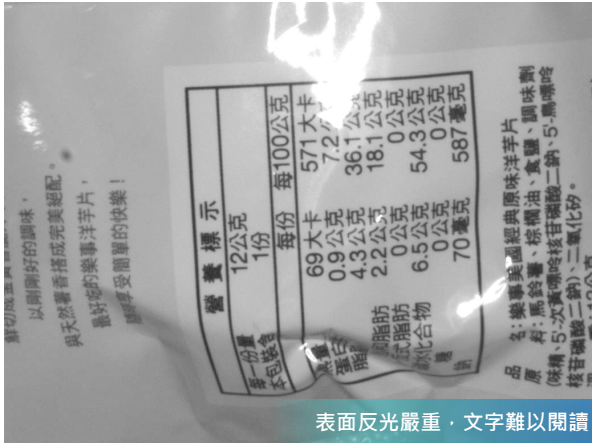

蝦條



乾奶袋

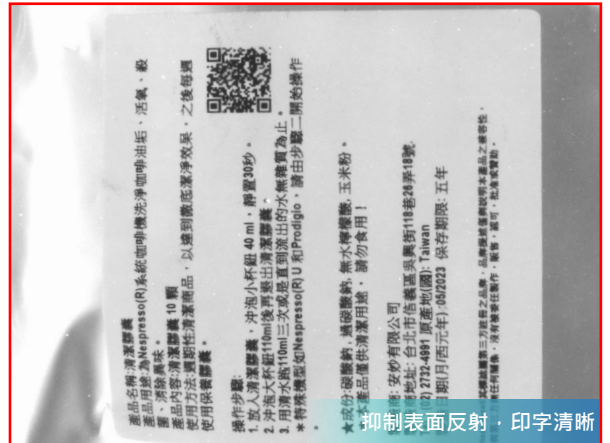
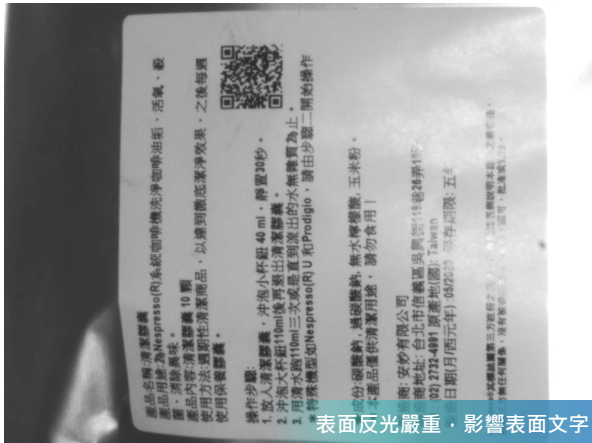

膠囊



環形光源 (白光)

薄型外同軸 (白光)

鐵鋁罐



表面反光嚴重，拉環輪廓模糊



光源均勻照射，拉環輪廓清晰

護手霜



表面反光嚴重，文字難以閱讀



抑制表面反射，印字清晰

乾燥劑



表面反光嚴重，文字難以閱讀



抑制表面反射，印字清晰

洋芋片



表面反光嚴重，影響表面文字



抑制表面反射，印字清晰

型號 (Model)	機構尺寸 (Mechanism size)	外觀尺寸 (Dimension)
FSDL-145120	145X120	A
FSDL-197170	197X170	B
FSDL-278197	278X197	C
FSDL-435300	435X300	D
FSDL-560322	560X322	E

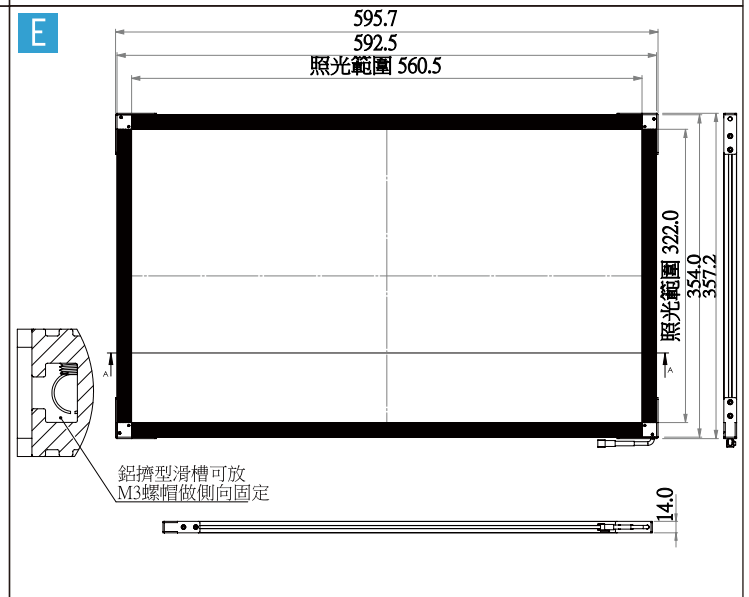
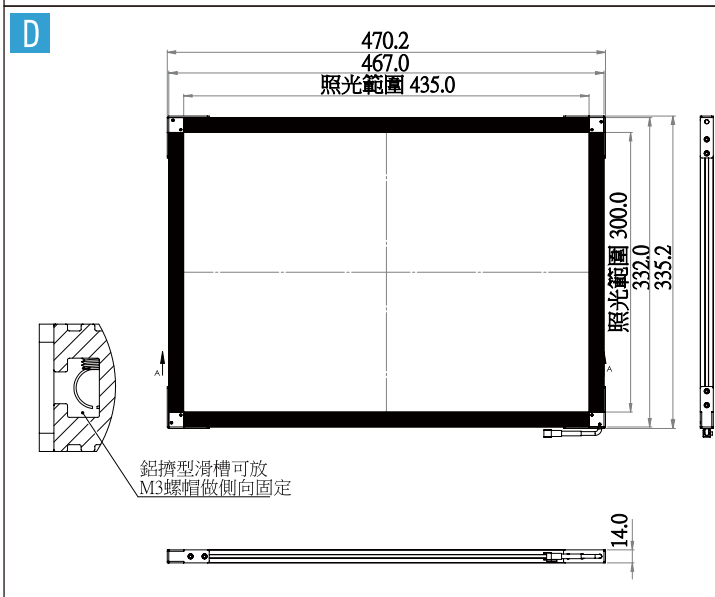
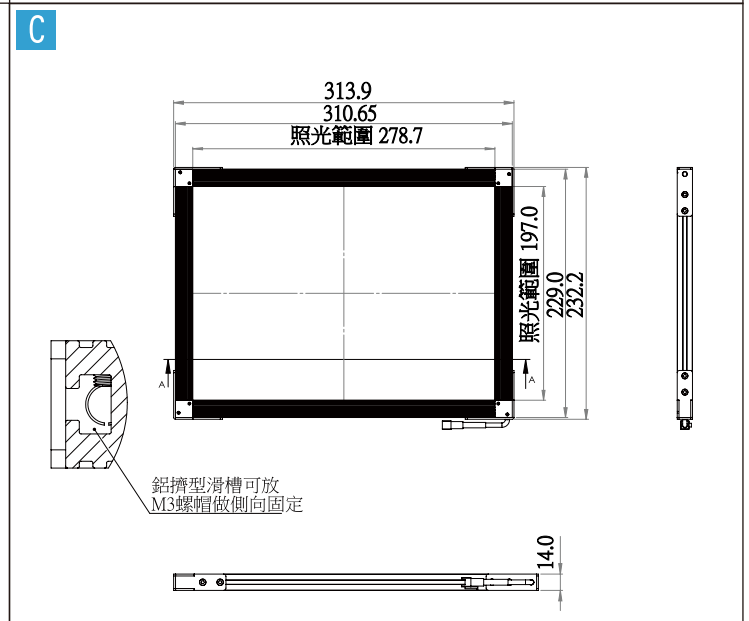
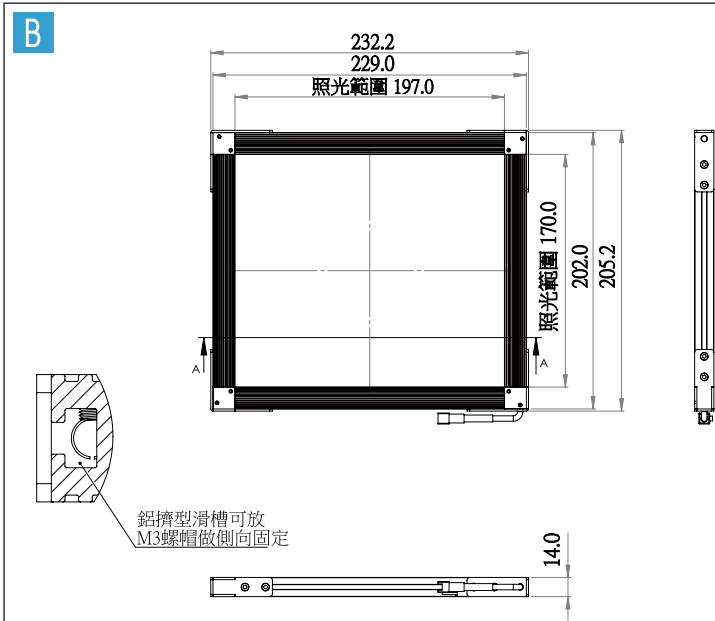
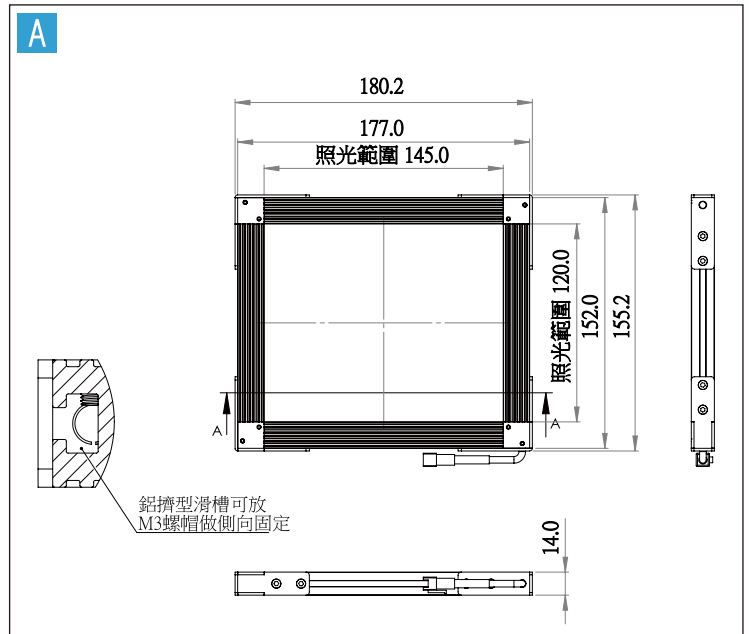

閃頻控制器



說明

※產品特色：

- 使用定電流恆流驅動LED，光源亮度穩定性及調光線性度均優於定電壓控制器。
- 提供完整的過熱/短路/過電壓/過負載 保護電路安全措施。
- 國際通用全範圍交流電輸入，提供0.7A~25A多款瓦數可供選擇。
- 調光器可搭配Overdriving，提升10倍亮度。



手動控制



支援程式控制

示意圖

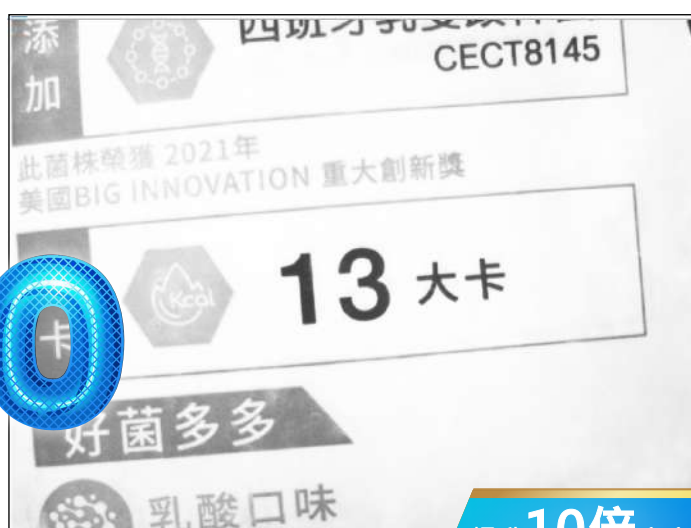
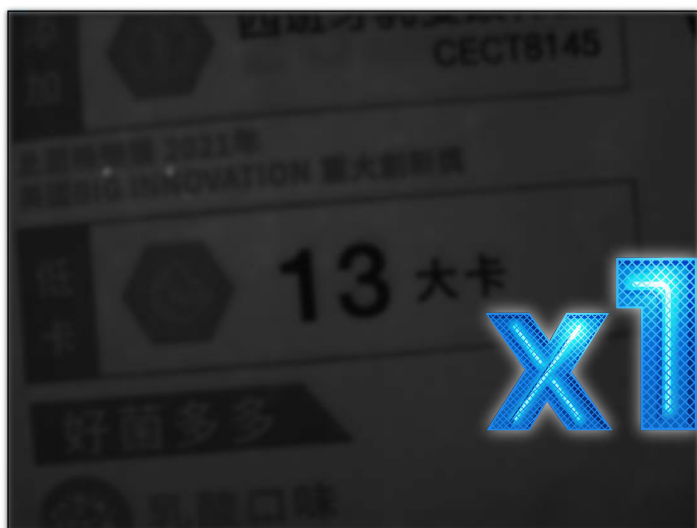

x10

提升10倍亮度

ision Intelligent

Viswell

宇創視覺科技股份有限公司

本手冊所列之產品規格如有更改，恕不另行通知 2024.06

TEL : 03-6583766 FAX : 03-6583266

新竹縣竹北市嘉豐七街 139 號

WEB : www.viswell.com.tw

官方 LINE : @viswell



免費借測



提供光源
實驗室

